

CBSE Class 12 Physics Question Paper 2021



Series 3HKP3B/C



SET~1

Code No. 55/1/1

Roll No.

--	--	--	--	--	--	--	--

Candidates must write the Code on the title page of the answer-book.

NOTE :

- (i) Please check that this question paper contains **11** printed pages.
- (ii) Code number given on the right hand side of the question paper should be written on the title page of the answer-book by the candidate.
- (iii) Please check that this question paper contains **33** questions.
- (iv) Please write down the serial number of the question in the answer-book before attempting it.
- (v) 15 minute time has been allotted to read this question paper. The question paper will be distributed at 10.15 a.m. From 10.15 a.m. to 10.30 a.m., the students will read the question paper only and will not write any answer on the answer-book during this period.

PHYSICS (Theory)



Time allowed : 3 hours



Maximum Marks : 70

General Instructions :

Read the following instructions very carefully and strictly follow them :

- (i) This question paper comprises **five** Sections – **A, B, C, D** and **E**.
- (ii) There are **33** questions in the question paper. **All** questions are compulsory.
- (iii) **Section A** – Questions no. **1** to **14** are very short answer type questions, carrying **one** mark each.
- (iv) **Section B** – Questions no. **15** and **16** are case study based short answer type questions, carrying **four** marks each.
- (v) **Section C** – Questions no. **17** to **25** are short answer type questions, carrying **two** marks each.
- (vi) **Section D** – Questions no. **26** to **30** are long answer type questions, carrying **three** marks each.
- (vii) **Section E** – Questions no. **31** to **33** are also long answer type questions, carrying **five** marks each.



- (viii) *There is no overall choice in the question paper. However, an internal choice has been provided in 4 questions of 1 mark, 3 questions of 2 marks, 2 questions of 3 marks and all the 3 questions of 5 marks. You have to attempt only one of the choices in such questions.*
- (ix) *In addition to this, separate instructions are given with each section and question, wherever necessary.*
- (x) *Use of calculators and log tables is **not** permitted.*
- (xi) *You may use the following values of physical constants wherever necessary :*

$$c = 3 \times 10^8 \text{ m/s}$$

$$h = 6.63 \times 10^{-34} \text{ Js}$$

$$e = 1.6 \times 10^{-19} \text{ C}$$

$$\mu_0 = 4\pi \times 10^{-7} \text{ T m A}^{-1}$$

$$\epsilon_0 = 8.854 \times 10^{-12} \text{ C}^2 \text{ N}^{-1} \text{ m}^{-2}$$

$$\frac{1}{4\pi\epsilon_0} = 9 \times 10^9 \text{ N m}^2 \text{ C}^{-2}$$

$$\text{Mass of electron (} m_e \text{)} = 9.1 \times 10^{-31} \text{ kg}$$

$$\text{Mass of neutron} = 1.675 \times 10^{-27} \text{ kg}$$

$$\text{Mass of proton} = 1.673 \times 10^{-27} \text{ kg}$$

$$\text{Avogadro's number} = 6.023 \times 10^{23} \text{ per gram mole}$$

$$\text{Boltzmann constant} = 1.38 \times 10^{-23} \text{ JK}^{-1}$$

SECTION A

1. Two wires X and Y of the same material and of equal lengths having area of cross-section A and 2A respectively, are connected in parallel across an ideal battery of emf E. What is the ratio of current density (j_X / j_Y) in them? 1
2. (a) An object approaches a converging lens with a uniform speed of 5 m/s and stops at the focus. How will the image move with respect to the lens? Specify its nature. 1
- OR**
- (b) In a simple microscope, a convex lens of focal length 5 cm is used. Calculate the magnifying power when the object is placed at the focus of the lens. 1
3. An alternating current $I = (10 \text{ A}) \sin (100 \pi t)$ is passed through a resistor of 20Ω . What is the average power consumed by the resistor over a complete cycle? 1
4. (a) What oscillates in an electromagnetic wave of frequency 10 MHz? 1
- OR**
- (b) Name the electromagnetic radiation used for killing germs in water purifiers. 1



5. What is the power of an equiconvex lens of refractive index n_2 dipped in a liquid of refractive index n_1 , where $n_1 < n_2$? 1
6. Why are neutrons preferred as better projectiles in causing nuclear reaction ? 1
7. If the frequency of the radiation incident on a photosensitive surface increases ($\nu > \nu_0$), how will the stopping potential change ? 1
8. (a) An electron is accelerated through a potential difference of 100 V. Calculate the de Broglie wavelength associated with it. 1
- OR**
- (b) A proton and a deuteron are moving with the same speed. Find the ratio of the de Broglie wavelength (λ_p / λ_d) associated with them. 1
9. How does the energy gap of an intrinsic semiconductor change when doped with a trivalent impurity ? 1
10. (a) In a p-n junction under equilibrium, there is no net current. Why ? 1
- OR**
- (b) On what factor does the wavelength of the light emitted by an LED depend ? 1

Note : For Questions number 11, 12, 13 and 14, two statements are given : one labelled Assertion (A) and the other labelled Reason (R). Select the correct answer to these questions from the codes (A), (B), (C) and (D) as given below :

- (A) Both Assertion (A) and Reason (R) are true and Reason (R) is the correct explanation of Assertion (A)
- (B) Both Assertion (A) and Reason (R) are true but Reason (R) is **not** the correct explanation of Assertion (A)
- (C) Assertion (A) is true but Reason (R) is false
- (D) Assertion (A) is false and Reason (R) is also false
11. Assertion (A) :
Higher the range of an ammeter, smaller is its resistance.
Reason (R) :
To increase the range of the ammeter, additional shunt needs to be connected across it. 1
12. Assertion (A) :
In most of the northern hemisphere, the north pole of the dip needle tilts upwards.
Reason (R) :
This gives the direction of magnetic field of the Earth at that place. 1
13. Assertion (A) :
The angle of minimum deviation for a prism is lesser for red light than that for blue light.
Reason (R) :
The refractive index of the material of a prism for blue light is greater than that for red light. 1



14. Assertion (A) :

In his study of photoelectric emission, Hallwachs connected a negatively charged zinc plate to an electroscope. He found that negatively charged particles were emitted from the zinc plate under the action of visible light.

Reason (R) :

An uncharged zinc plate becomes positively charged when it is irradiated by visible light.

1

SECTION B

Note : Questions number 15 and 16 are case-study based questions and are compulsory. Attempt any 4 sub-parts from each question. Each sub-part carries 1 mark.

15. A potentiometer draws a steady current from the battery (B) of emf E in the circuit as shown in the figure. The balancing length for the cell of emf ϵ when key K_2 is kept open, is l_1 . If key K_2 is closed and a resistance S is introduced in the resistance box (RB), the balancing length becomes l_2 .

4×1=4

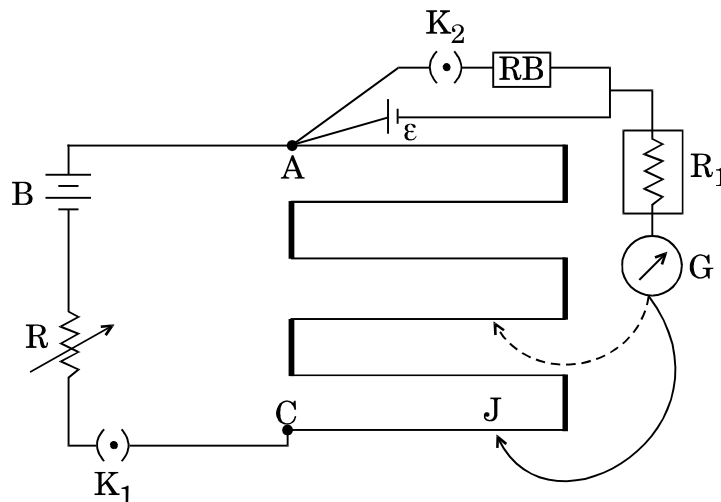

- (i) The balancing length $l_1 > l_2$ because
 - (A) $E > \epsilon$.
 - (B) positive terminal of the battery is connected to positive terminal of the cell.
 - (C) the voltage drop across the cell is greater than that across the battery.
 - (D) terminal potential difference of the cell is less than its emf.

- (ii) The high resistance R_1 in the circuit is used to
 - (A) keep the balance point near the mid-point of the potentiometer wire AC.
 - (B) reduce the current supplied by the battery (B) to zero at balance point.
 - (C) protect the galvanometer from damage due to large current.
 - (D) make the galvanometer more sensitive.



- (iii) If the key K_2 is kept open and resistance R is increased, the balancing length AJ of the wire will
- (A) increase.
 - (B) decrease.
 - (C) remain unaffected.
 - (D) become zero.
- (iv) Two potentiometers P and Q use the same wire of lengths 5 m and 10 m respectively, between A and C . They are connected to battery (B) in the circuit separately. The potentiometer which is preferred to compare the emfs of two cells is
- (A) P , because potential gradient is less.
 - (B) Q , because potential gradient is less.
 - (C) P , because current is more.
 - (D) Q , because resistance of the potentiometer is less.
- (v) The reason for preferring manganin wire in a potentiometer is because
- (A) of high value of its temperature coefficient of resistivity.
 - (B) of its low resistivity.
 - (C) of low value of its temperature coefficient of resistivity.
 - (D) its resistance decreases with increase in temperature.

16. In Rutherford's nuclear model of the atom, the entire positive charge and most of the mass of the atom are concentrated in the nucleus. The electrons move in orbits around the nucleus. The nucleus is made of protons and neutrons. Because the nucleus is extremely small as compared to the atom, most of an atom is empty space. The protons and the neutrons are held together in the nucleus by very strong nuclear forces. $4 \times 1 = 4$

(i) The radius R of a nucleus of mass number A is given by

- (A) $R = R_0 A^3$
- (B) $R = R_0 A^{1/3}$
- (C) $R = R_0^3 A$
- (D) $R = R_0^3 A^{1/3}$

(ii) The ratio of nuclear density of nuclei X^{27} to Y^8 is

- (A) $3 : 2$
- (B) $27 : 8$
- (C) $1 : 1$
- (D) $2 : 3$



(iii) In the following nuclear reaction

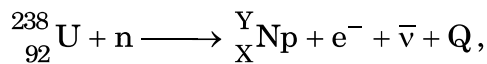

the values of X and Y are

- (A) X = 92; Y = 238
(B) X = 92; Y = 239
(C) X = 93; Y = 239
(D) X = 93; Y = 238
- (iv) The saturation property of the nuclear forces is due to the fact that they are
- (A) charge independent forces.
(B) non-central forces.
(C) spin-dependent forces.
(D) short-range forces.
- (v) In Geiger-Marsden scattering experiment, thin gold foil is used to scatter alpha particles because alpha particles will
- (A) not suffer more than one scattering and gold nucleus is 50 times heavier than alpha particle.
(B) not suffer more than one scattering and gold nucleus is lighter than alpha particle.
(C) not suffer more than few scatterings and gold nucleus is 25 times heavier than alpha particle.
(D) suffer more than one scattering and gold nucleus is 25 times heavier than alpha particle.

SECTION C

17. Define drift velocity of electrons in a conductor connected across a battery. Figure shows variation of the drift velocity (v_d) of electrons in two copper wires A and B of different lengths versus the potential difference (V) applied across their ends.

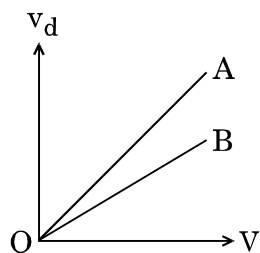

- (i) What does the slope of the line represent ?
(ii) Which one of the two wires is longer ? 2
18. (a) (i) The angle of dip at a location in southern India is about 18° . Would you expect a greater or smaller dip angle in Britain ? Justify your answer.
(ii) "The declination in India is small, it being $0^\circ 41'$ E at Delhi and $0^\circ 58'$ W at Mumbai." What is the significance of this statement ? 2

OR



- (b) The magnetic moment of a circular coil carrying current I , having N turns, each of radius r , is M . Find the magnetic moment of the same coil if it is unwound and rewound into a coil having $2N$ turns for the same current. 2
19. Two identical circular discs, one of copper and another of aluminium, are rotated about their geometrical axes with same angular speed in the same magnetic field acting perpendicular to their planes. Compare the (i) induced emf, and (ii) induced current produced in discs between its centre and edge. Justify your answers. 2
20. (a) The electric field of an electromagnetic wave is represented as $E_x = E_0 \sin(\omega t + kz)$.
- (i) In which direction is the wave propagating ?
- (ii) In which direction does the magnetic field oscillate ?
- (b) Write two characteristics of electromagnetic waves. 2
21. A ray of light falls on a transparent sphere of $n = \sqrt{3}$ at an angle of incidence 60° with the diameter AB of the sphere having centre C . The ray emerges from the sphere parallel to the line AB . Find the angle of emergence. 2

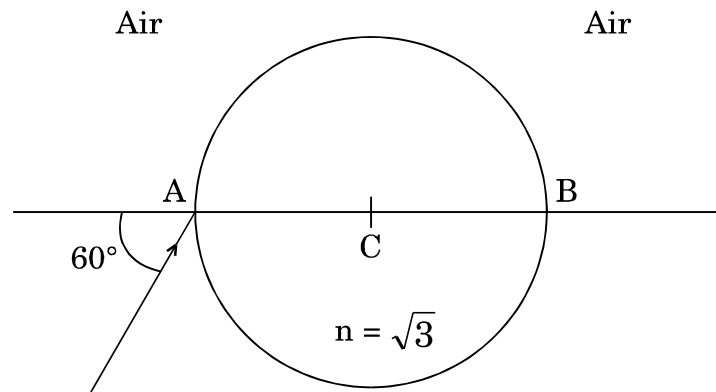

22. (a) How would the angular width of central maximum of diffraction pattern be affected when (i) width of the slit is decreased, and (ii) monochromatic light is replaced by polychromatic light ? Justify your answers. 2
- OR**
- (b) In interference of light, write the expression for the intensity of resultant wave if I_0 is the intensity of light wave from each slit. Hence, obtain an expression for the intensity of resultant wave if the two sources are (i) incoherent, and (ii) coherent. 2
23. For the light of wavelength 400 nm incident on the cathode of a photocell, the stopping potential is 6 V . If the wavelength of incident light is increased to 600 nm , calculate the new stopping potential. (Take $h = 4.14 \times 10^{-15} \text{ eV} \cdot \text{s}$) 2
24. (a) With the help of the circuit diagram, explain the working of a diode as a half-wave rectifier. 2
- OR**
- (b) With the help of the circuit diagram, explain briefly the working of a photodiode. 2



25. (a) State whether the given ideal diodes are forward or reverse biased :

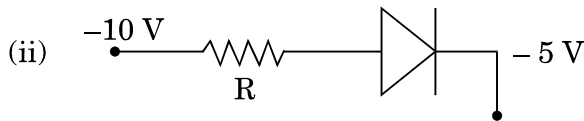
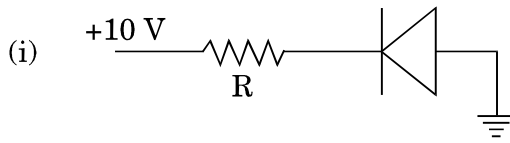

(b) The current in the forward bias is known to be more (\sim mA) than the current in the reverse bias (\sim μ A). What is the reason then to operate the photodiodes in reverse bias ?

2

SECTION D

26. (a) Two concentric circular coils X and Y of radii r_1 and r_2 ($r_1 > r_2$) having N_1 and N_2 turns respectively are placed coaxially with centres coinciding. Obtain an expression for (i) the mutual inductance for the arrangement, and (ii) the magnetic flux linked with coil Y when current I flows through coil X.

3

OR

(b) What are eddy currents ? Why does the pendulum plate with holes or slots reduce electromagnetic damping ? How are the eddy currents minimised in the core of a transformer ? Why is the electromagnetic braking effect smooth in a train ?

3

27. (a) A uniformly charged large plane sheet has charge density $\sigma = \left(\frac{1}{18\pi}\right) \times 10^{-15}$ C/m². Find the electric field at point A which is 50 cm from the sheet.

Consider a straight line with three points P, Q and R, placed 50 cm from the charged sheet on the right side as shown in the figure. At which of these points, does the magnitude of the electric field due to the sheet remain the same as that at point A and why ?

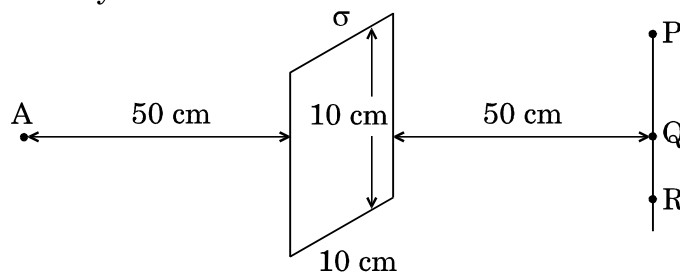

(b) Two small identical conducting spheres carrying charge $10 \mu\text{C}$ and $-20 \mu\text{C}$ when separated by a distance of r , experience a force F each. If they are brought in contact and then separated to a distance of $\frac{r}{2}$, what is the new force between them in terms of F ?

3



28. (a) (i) In an LCR series circuit connected to an ac source, the voltage and the current are in the same phase. If the capacitor is filled with a dielectric, will the current lead or lag behind or remain in phase with the voltage ? Explain. 3
- (ii) In the circuit, why is the rms value of net voltage not equal to the sum of voltage drops across individual elements ?
- (iii) Draw a graph showing variation of the impedance of the circuit with the frequency of the applied voltage. 3

OR

- (b) (i) An LCR series circuit is connected to an ac source. If the angular resonant frequency of the circuit is ω_0 , will the current lead or lag behind or be in phase with the voltage when $\omega < \omega_0$ and why ?
- (ii) We cannot step up a dc voltage using a transformer. Why ?
- (iii) On what principle does a metal detector work ? 3
29. (a) Explain the formation of the fringes due to diffraction at a single slit, when path difference of light waves from the ends of the slit on reaching a point on the screen is (i) λ , and (ii) $\frac{3\lambda}{2}$.
- (b) Show the intensity distribution in the fringes due to diffraction at a single slit. 3
30. (a) In a Geiger-Marsden experiment, find the distance of closest approach to the gold nucleus (mass no. = 79) of a 7.7 MeV α -particle before it comes momentarily to rest and reverses its direction. Why is it different from actual radius of gold nucleus ?
- (b) Plot a graph between number of scattered α -particles detected in gold foil experiment and angle of scattering. What is the main assumption in plotting this graph ? 3

SECTION E

31. (a) (i) Draw a ray diagram of an astronomical refracting telescope in normal adjustment. Obtain an expression for its magnifying power. How can we increase the magnifying power of the telescope ?
- (ii) A beam of light converges at a point P. A lens is placed in the path of the beam at a distance of 25 cm from P. The final image is formed at infinity. Calculate the power of the lens. 5

OR

- (b) (i) A coin is placed inside a denser medium. Why does it appear to be raised ? Obtain an expression for the height through which the object appears to be raised in terms of refractive index of the medium and real depth.



- (ii) A compound microscope consists of an objective lens of focal length 2 cm and an eyepiece of focal length 6.25 cm separated by a distance of 15 cm. How far from the objective should an object be placed in order to obtain the final image at the least distance of distinct vision (25 cm) ? Calculate the magnifying power of the microscope.

5

32. (a) (i) An α -particle, a deuteron and a proton enter into a uniform magnetic field normally with the same kinetic energy and describe circular paths. Find the ratio of radii of their paths.

- (ii) Give the direction of magnetic field acting on the current carrying coil ACDE shown in the figure so that the coil is in unstable equilibrium.

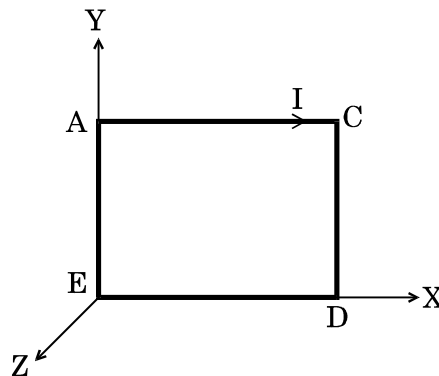

- (iii) Why do we use a low resistance ammeter in a circuit to measure current ?

5

OR

- (b) (i) Draw a diagram to show the magnetic field lines produced by two parallel straight wires carrying currents in the same direction. Obtain an expression for the force per unit length between these wires and hence define SI unit of current.

- (ii) The figure shows a circular loop connected to a battery. The arc ACB of length l_1 carries a current I_1 and arc ADB of length l_2 carries a current I_2 . Show that the net magnetic field at the centre of the loop is zero.

5

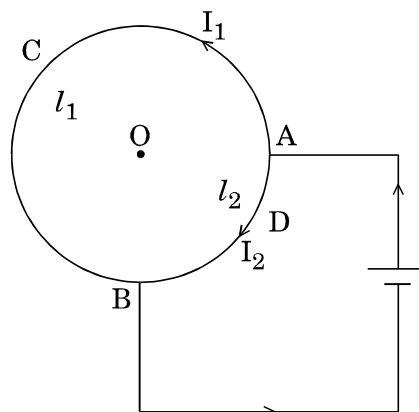



33. (a) (i) (A) Why does the electric field inside a dielectric slab decrease when kept in an external electric field ?
- (B) Derive an expression for the capacitance of a parallel plate capacitor filled with a medium of dielectric constant K .
- (ii) A charge $q = 2 \mu\text{C}$ is placed at the centre of a sphere of radius 20 cm. What is the amount of work done in moving $4 \mu\text{C}$ from one point to another point on its surface ?
- (iii) Write a relation for polarisation \vec{P} of a dielectric material in the presence of an external electric field. 5

OR

- (b) (i) Obtain an expression for the potential energy of an electric dipole placed in a uniform electric field.
- (ii) Three capacitors of capacitance C_1 , C_2 and C_3 are connected in series to a source of V volt. Show that the total energy stored in the combination of capacitors is equal to sum of the energy stored in individual capacitors.
- (iii) A capacitor of capacitance C is connected across a battery. After charging, the battery is disconnected and the separation between the plates is doubled. How will (i) the capacitance of the capacitor, and (ii) the electric field between the plates be affected ? Justify your answer. 5